

High performance liquid-solids separation systems

HTH

Exclusive internal acceleration creates maximum performance to achieve maximum protection of fluid handling systems from unwanted solids (see illustration inside for details). Its advanced & patented design, building upon the performance LAKOS is known for, now also removes 50% more of the finer solids (< 40 microns), resulting in higher aggregate solids removal. Independently tested. Proven superior for today's demanding filtration requirements. For settleable solids only.

Trouble-free operation & advanced purging/solids-handling concepts keep fluids clean and concentrate separated solids

No screens or filter elements to clean or replace; no messy servicing routines

No backwashing; zero fluid loss options

Low & steady pressure loss

Choice of profiles to accommodate space/piping limitations

Swirlex internal accelerating slots for optimum solids-removal performance; patented

Vortube for enhanced solids separation/collection; patented

Grooved inlet/outlet connections for easy installation

In-line inlet/outlet configuration for simplified piping (low-profile models only)

Unishell construction for easy installation

Optional material construction & ASME code



Flow range:
285 - 12,750 U.S. gpm
(65 - 2895 m³/hr) per unit

Maximum standard
pressure rating:
150 psi (10.3 bar)

How-it-Works Illustration

Model Specifications

Installation & Operating Instructions

Maintenance & Purging

Engineering Specifications



LAKOS is a proud member of ASHRAE, BOMA and the U.S. Green Building Council

LAKOS
Separators and Filtration Solutions

How It Works

Solids Removal Chart

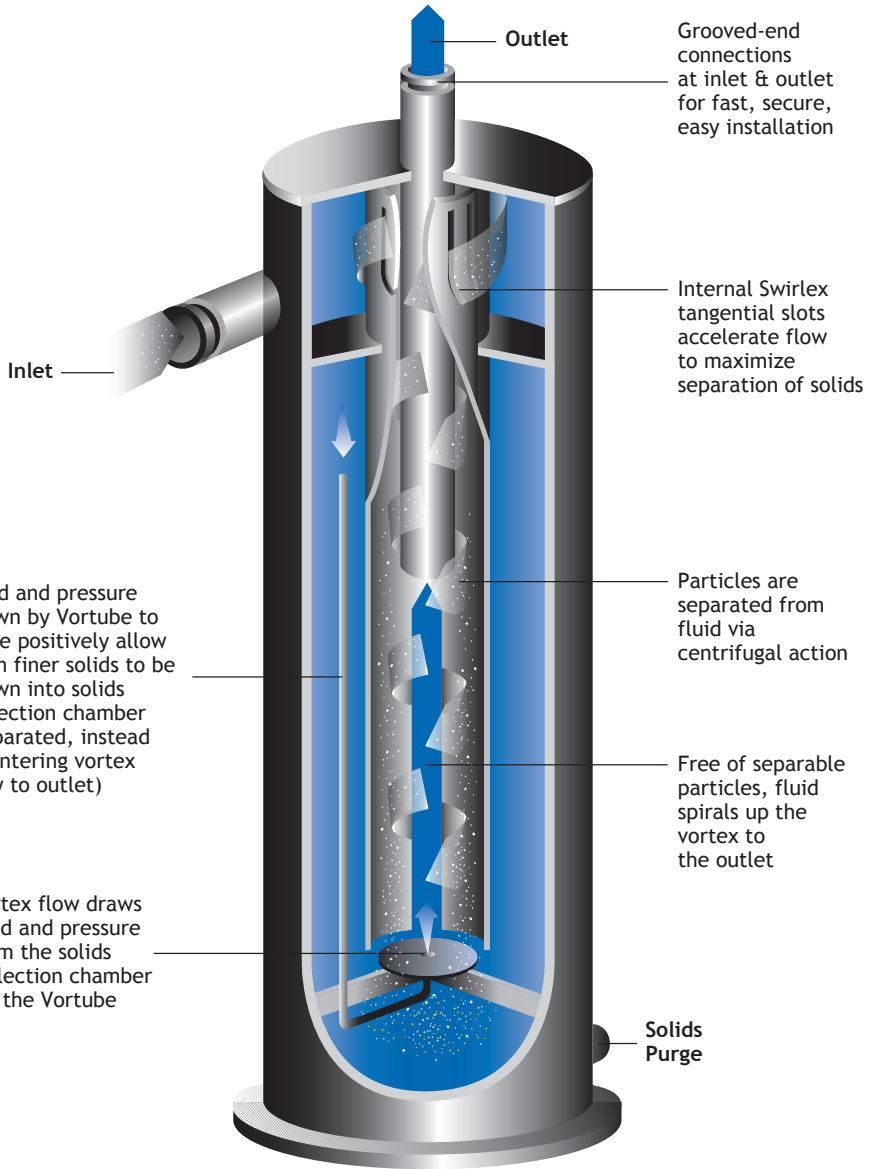
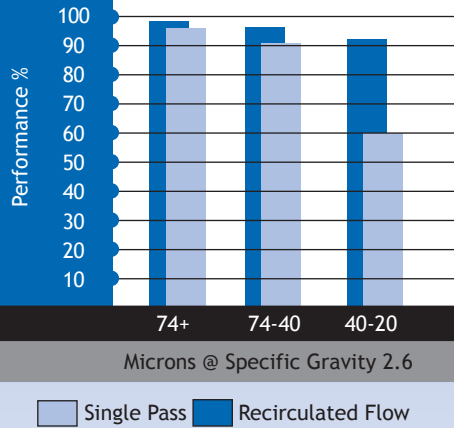

HTH Installation

with Optional SRV Package

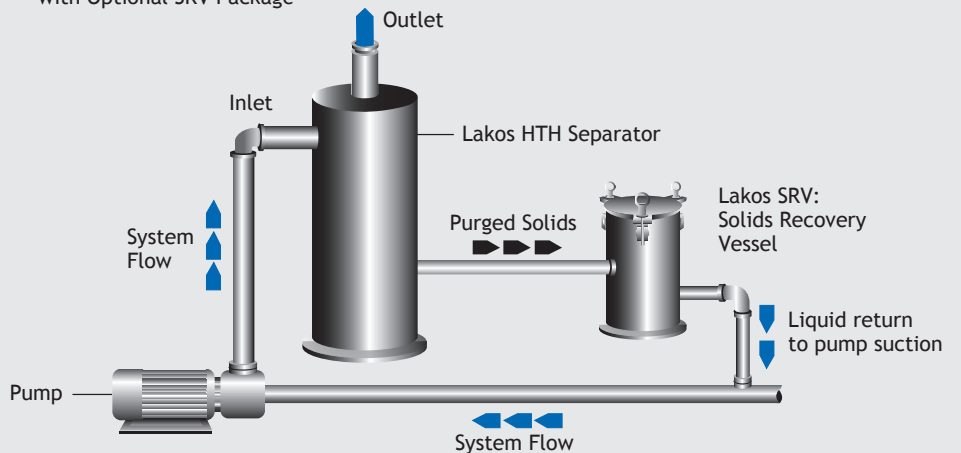

Lakos Separators are manufactured and sold under one or more of the following U.S. Patents: 5,320,747; 5,338,341; 5,368,735; 5,425,876; 5,571,416; 5,578,203; 5,622,545; 5,653,874; 5,894,995; 6,090,276; 6,143,175; 6,167,960; 6,202,543; 7,000,782; 7,032,760 and corresponding foreign patents, other U.S. and foreign patents pending.

Specifications

Model*	Flow Range		Inlet/Outlet Grooved Coupling**	Purge Size Male N.P.T.	Collection Chamber Capacity		Weight		Weight with Water	
	U.S. gpm	m ³ /hr			gal	liter	lbs	kg	lbs	kg
HTH-0285-L HTH-0285-V	285-525	65-120	4"	1-1/2"	2.1 3.8	7.9 14.4	445 387	202 176	720 625	326 284
HTH-0450-L HTH-0450-V	450-825	100-190	6"	1-1/2"	2.8 5.6	10.6 21.2	591 548	268 249	1005 962	456 437
HTH-0500-L HTH-0500-V	500-1100	115-250	6"	1-1/2"	2.8 5.6	10.6 21.2	598 556	271 252	1012 924	459 419
HTH-0810-L HTH-0810-V	810-1670	185-380	8"	1-1/2"	6.2 9.1	23.5 34.4	674 698	306 317	1363 1470	618 667
HTH-1275-L HTH-1275-V	1275-3100	290-705	10"	2"	11.5 21.8	43.5 82.5	894 920	406 417	2393 2306	1085 1046
HTH-1950-L HTH-1950-V	1950-4350	440-990	12"	2"	15.0 30.0	56.8 113.6	1095 1175	497 533	3087 3024	1400 1372
HTH-3500-L HTH-3500-V	3500-6800	795-1545	16"	2"	50.6 81.3	191.5 307.8	2949 2591	1338 1175	9042 8159	4101 3701
HTH-6700-L HTH-6700-V	6700-12750	1522-2895	20"	2"	81.0 62.0	306.6 613.2	6023 5608	2732 2544	16789 15530	7615 7044

*Models ending with "L" are low profile, "V" for vertical profile

**Inlet/Outlet may also be specified with ANSI flanges or DIN flanges

Maximum pressure rating: 150 psi (10.3 bar); consult factory for higher pressure requirements

Pressure loss range: 3 - 12 psi (.2 - .8 bar)

Maximum particle size: .375 inch (9 mm)

Material (standard carbon steel): Domes - A 285C/516 GR70, .25 inch (6 mm) minimum thickness

Other parts - A - 36, A - 53B or other quality grade, .25 inch (6 mm) minimum thickness

Paint coating: Acrylic urethane, spray-on black

Flow vs. Pressure Loss

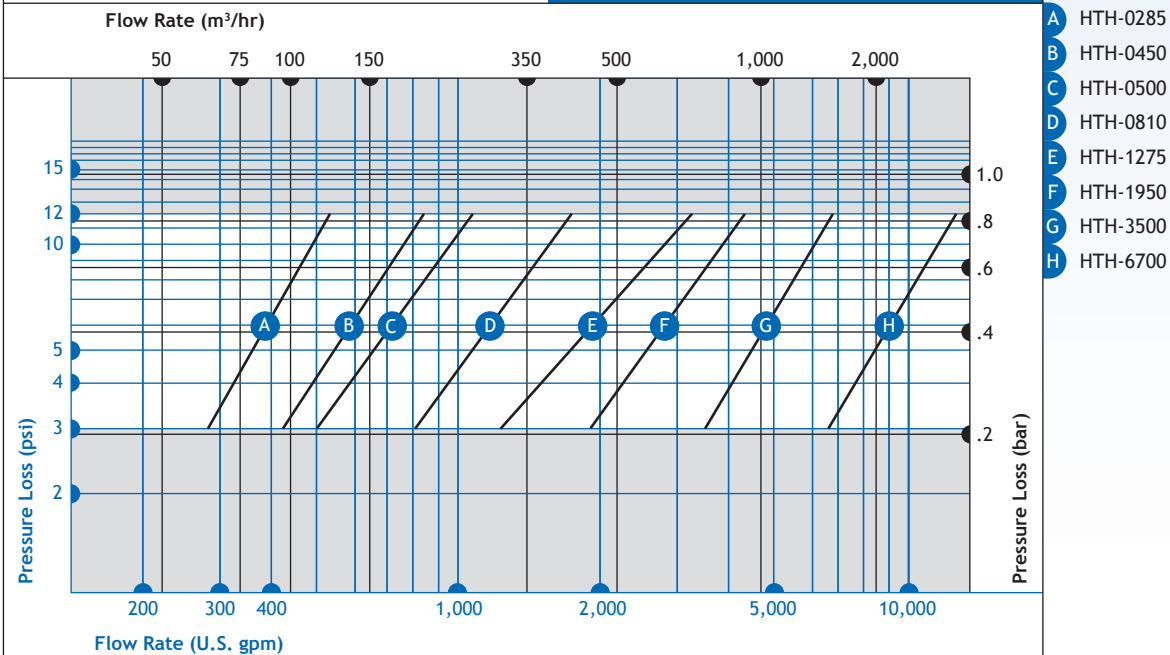

HTH Low Profile

Inlet/Outlet Pressure Gauge Taps

1/4-inch NPT female; required at both inlet and outlet for proper flow verification; optional kit available, including inlet/outlet pressure gauges with petcock valves and a manual isolation valve for the purge connection

Inspection/Drain Plug

1/2-inch NPT female; provides access to upper chamber for inspection of slot area; also allows for draining the upper chamber if necessary

Lifting Ring

For installation purposes

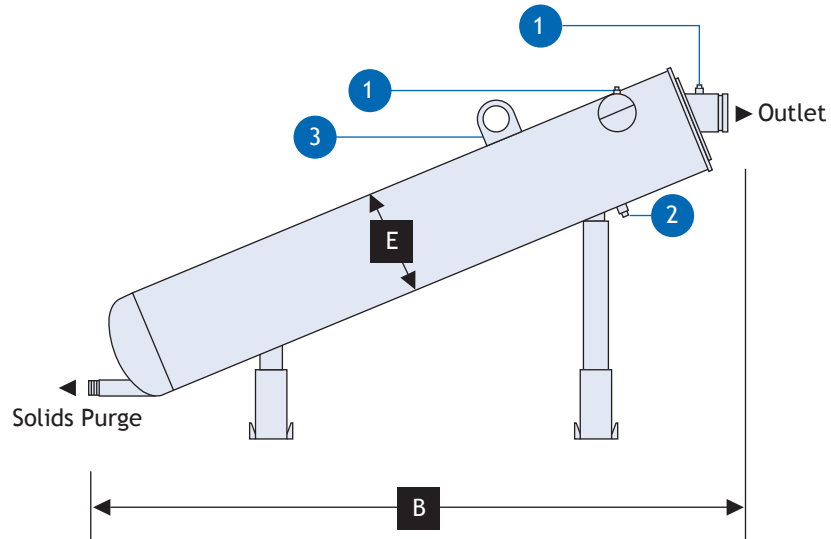
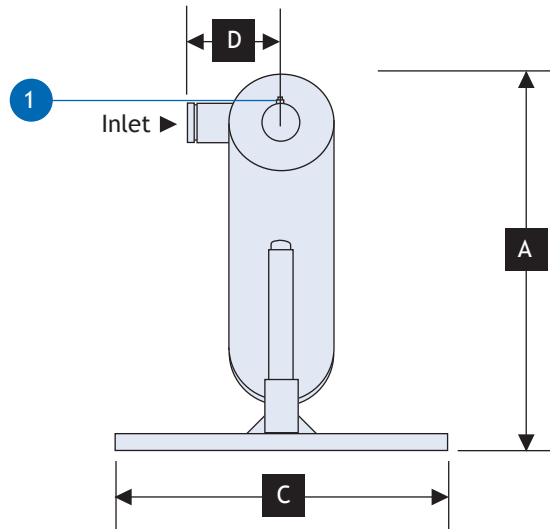

Dimensions

Model	A		B		C		D		E	
	in	mm	in	mm	in	mm	in	mm	in	mm
HTH-0285-L	41-13/16	1062	70-3/16	1783	40	1016	11	279	12-3/4	324
HTH-0450-L	49-1/8	1248	85	2159	40	1016	12	305	14	356
HTH-0500-L	49-1/8	1248	85	2159	40	1016	12	305	14	356
HTH-0810-L	54-5/8	1387	92-13/16	2357	40	1016	18-7/8	479	18	457
HTH-1275-L	68-1/2	1740	118-13/16	3018	40	1016	18	457	22	559
HTH-1950-L	74-3/32	1882	130	3302	40	1016	18	457	24	610
HTH-3500-L	105-5/16	2675	189-7/16	4812	60	1524	26	660	36	914
HTH-6700-L	125	3175	225	5715	60	1524	30	762	42	1067

*Dimensions for reference only.
Consult factory when pre-plumbing.*

HTH Vertical

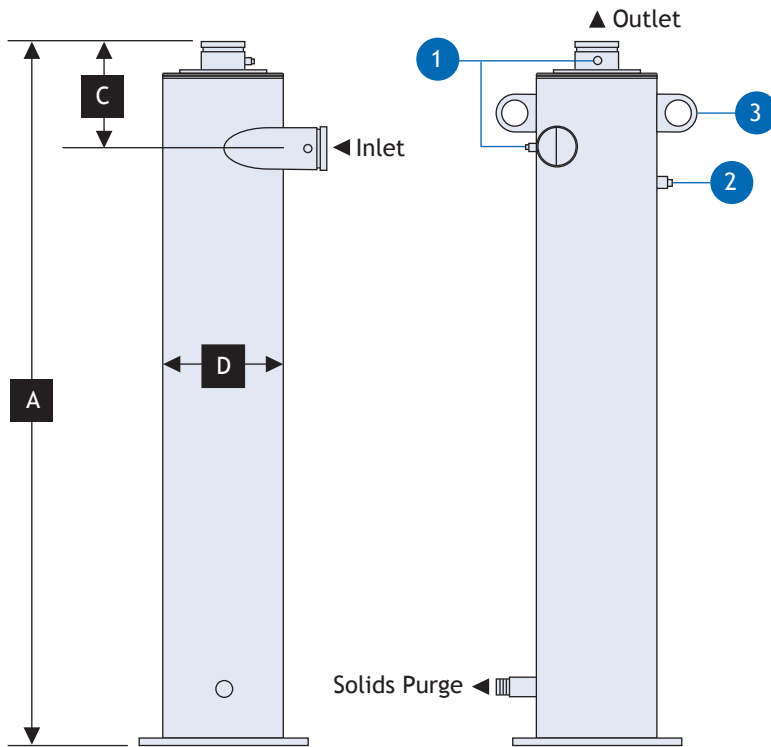

1 Inlet/Outlet Pressure Gauge Taps

1/4-inch NPT female; required at both inlet and outlet for proper flow verification; optional kit available, including inlet/outlet pressure gauges with petcock valves and a manual isolation valve for the purge connection

2 Inspection/Drain Plug

1/2-inch NPT female; provides access to upper chamber for inspection of slot area; also allows for draining the upper chamber if necessary

3 Lifting Rings

For installation purposes

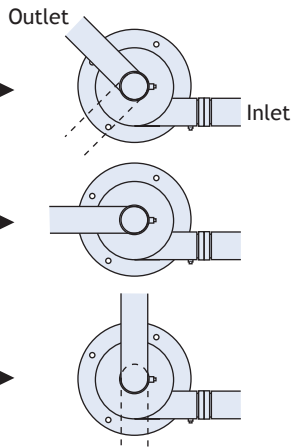

Recommended Direction of Inlet/Outlet Piping to Control Vibration

Top Views

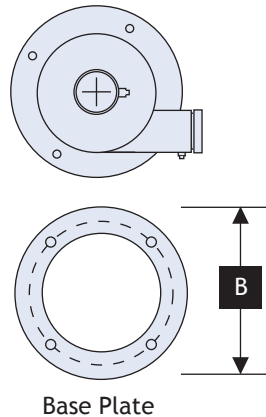

Dimensions

Model	A		B		C		D	
	in	mm	in	mm	in	mm	in	mm
HTH-0285-V	66-9/16	1691	18	457	14-3/16	360	12-3/4	324
HTH-0450-V	82-5/16	2091	20	508	13-3/8	317	14	356
HTH-0500-V	82-5/16	2091	20	508	13-3/8	317	14	356
HTH-0810-V	91	2311	26	660	16-7/16	418	18	457
HTH-1275-V	117-3/16	2977	30	762	18-1/2	470	22	559
HTH-1950-V	129-15/16	3300	32	812	18-3/4	476	24	610
HTH-3500-V	180-15/16	4596	44	1118	37	940	36	914
HTH-6700-V	218-1/4	5544	48	1219	40-7/16	1027	42	1067

Dimensions for reference only. Consult factory when pre-plumbing.

Installation Instructions

Maintenance/Purging

1. LAKOS HTH Separators must be purged regularly to remove the separated solids from the temporary collection chamber.

2. All purge hardware should be installed prior to any elbows or turns in the purge piping. Avoid "uphill" purging, which can clog purge piping and hinder effective solids evacuation.

3. For best results, purging is recommended while the LAKOS Separator is in operation, utilizing system pressure to enhance solids evacuation.

4. LAKOS provides a full selection of rugged, durable automatic purging and solids-handling systems to optimize the performance of your separation system. CAUTION: Economy-type valves typically fail prematurely in the harsh/abrasive environment of solids purging.

5. Be sure to include an isolation valve prior to the automatic valve (available from LAKOS at an additional cost) in order to facilitate servicing of the automatic valve without system shutdown.

- 1 LAKOS HTH Separators are shipped on skids or in wooden crates. Support legs (low profile units only) are detached for shipping. A large ring, located on the unit's side or upper chamber, is provided for hoisting as necessary.
- 2 A suitable foundation is necessary to accommodate the LAKOS Separator's weight including liquid (see data, page 3). Anchor bolts are recommended in the base of the legs (low profile) or skirt (vertical profile).
- 3 Prior to installation, inspect the inlet/outlet/purge connections for foreign objects incurred during shipping/storage.
- 4 Inlet/outlet pipe connections to the LAKOS Separator should be a straight run of at least five pipe diameters to minimize turbulence and enhance performance.
- 5 Proper purge hardware and/or solids-handling equipment is required to flush separated solids from the separator (see details, page 2).
- 6 All LAKOS Separators operate within a prescribed flow range (see data, page 3). Pipe size is not a factor in model selection. Use appropriate hardware to match the inlet/outlet size. Grooved couplings are not included with the separator. Optional flanged connections are available upon request.
- 7 Inlet pressure to the LAKOS Separator must be at least equal to or greater than the anticipated pressure loss through the separator (see pressure loss chart, page 3) plus 15 psi (1 bar) plus whatever downstream pressure is required.
- 8 Pressure gauges are required at both the inlet and outlet of the separator in order to monitor pressure loss and proper system flow (see "Flow vs. Pressure Loss" chart, page 3). Gauge kit available from LAKOS at additional cost. If separator operates with an open discharge, a valve should be installed to create a back pressure of at least 5 psi (.3 bar).
- 9 Winterizing is important if the LAKOS Separator is to remain idle in freezing temperatures. Drain liquid as necessary to avoid expansion of water to ice and related damages.

Sample Specifications

Separator Type & Performance

The removal of specific unwanted solids from a pumped/pressurized fluid flow system shall be accomplished with a centrifugal-action vortex separator. Solids removal efficiency is principally predicated on the difference in specific gravity between the liquid and the solids. Fluid viscosity must be 100 SSU or less.

In a single pass through the separator, given solids with a specific gravity of 2.6 and water at 1.0, performance is predictably 98% of 74 microns and larger. Additionally, particles finer in size, heavier by specific gravity and some lighter by specific gravity will also be removed, resulting in an appreciable aggregate removal of particles (up to 75%) as fine as 5 microns.

In a recirculating system, 98% performance is predictable to as fine as 40 microns (given solids with a specific gravity of 2.6), with correspondingly higher aggregate performance percentages (up to 90%) of finer solids.

Performance Requirement

Separator performance must be supported by published independent test results from a recognized and identified test agency. Standard test protocol of upstream injection, downstream capture and separator purge recovery is allowed with 50-200 mesh particles to enable effective, repeatable results. Single-pass test performance must not be less than 95% removal. Model tested must be of the same flow-design series as specified unit.

Separator Design & Function

A tangential inlet and mutually tangential internal accelerating slots shall be employed to promote the proper velocity necessary for the removal of the separable solids. The internal accelerating slots shall be spiral-cut for optimum flow transfer, laminar action and particle influence into the separation barrel. The separator's internal vortex shall allow this process to occur without wear to the accelerating slots.

Separated particle matter shall spiral downward along the perimeter of the inner separation barrel, in a manner which does not promote wear of the separation barrel, and into the solids collection chamber, located below the vortex deflector plate.

To insure maximum particle removal characteristics, the separator shall incorporate a vortex-induced pressure relief line (Vortube), drawing specific pressure and fluid from the separator's solids collection chamber via the outlet flow's vortex/venturi effect, thereby efficiently encouraging solids into the collection chamber without requiring a continuous underflow or excessive system fluid loss.

System fluid shall exit the separator by following the center vortex in the separation barrel and spiral upward to the separator outlet.

Purging & Solids Handling

Evacuation of separated solids shall be accomplished automatically, employing a dedicated solid-state controller in a NEMA 4 housing. Available for worldwide single-phase voltages of 24VAC to 250VAC. Programming options to include a purge frequency range of every 60 seconds to every 23 hours, 59 minutes. Purge duration options range from 10 seconds to 59 minutes, 59 seconds. Non-volatile memory. Meets CSA requirements. This controller shall automatically operate one of the following techniques:

Motorized Ball Valve - An electrically-actuated valve shall be programmed at appropriate intervals and duration in order to efficiently and regularly purge solids from the separator's collection chamber. Valve body shall be bronze (optional stainless steel also available). Valve ball shall be stainless steel with sealant seat. Valve size: _____

Pneumatic Ball Valve - A fail-safe valve shall be programmed at appropriate intervals and duration in order to efficiently and regularly purge solids from the separator's collection chamber. A spring-control shall provide that this valve closes in the event that compressed air or electricity is interrupted. Valve body shall be bronze (optional stainless steel also available). Valve ball shall be stainless steel with sealant seat. Valve size: _____

Solids Recovery Vessel - Separated solids shall be continuously purged under controlled flow into a vessel equipped with one (or three, depending on the model specified) 25-micron fiberfelt solids collection bag. Solids collection capacity: 360 cubic inches (6 liters). If larger vessel is specified: 1080 cubic inches (18 liters). Excess liquid shall pass through the bag and return to system flow via piping connected to the system pump's suction line. The system shall include an air/pressure relief line for the vessel. If optional Indicator Package has been specified: System also includes manual isolation valves for use when servicing the collection bag; sightglasses for verification of flow through the vessel; annunciator for indicating when the collector bag needs cleaning/replacement; flow control orifice to minimize fluid volume/velocity through the vessel and collector bag; clamps, tubing and specialty piping for completing the system assembly.

Systemization (A specified option only)

The separator and its accessories shall be packaged as a complete system, with all componentry from a single source. In addition to the equipment already specified, the system shall also include pressure gauges with petcock valves for both the inlet and outlet of the separator and an isolation valve at the purge outlet for servicing of the automatic valve as necessary without interrupting system flow.

Separator Details

- A. Inlet & outlet shall be grooved connections, size: _____
- B. Purge outlet shall be threaded size: _____
- C. The separator shall operate within a flow range of: _____
- D. Pressure loss shall be between 3-12 psi (.2 - .8 bar), remaining constant, varying only when the flow rate changes.

Separator Construction

The separator shall be of unishell construction with A-36, A-53B or equivalent quality carbon steel, minimum thickness of .25 inches (6.35 mm). Maximum operating pressure shall be 150 psi (10.3 bar), unless specified otherwise.

Paint coating shall be acrylic urethane, spray-on, gloss black.

As a specified option only: The separator shall be constructed in accordance with the standards of the American Society of Mechanical Engineers (ASME), Section VIII, Division 1 for pressure vessels. Certification shall be confirmed with the registered "U-stamp" on the body of the separator.

Separator Source & Identification

The separator shall be manufactured by LAKOS Filtration Systems, a division of Claude Laval Corporation in Fresno, California USA.

Specific model designation is: _____

Limited Warranty

All products manufactured and marketed by this corporation are warranted to be free of defects in material or workmanship for a period of at least one year from date of delivery. Extended warranty coverage applies as follows:

All LAKOS Separators:
Five year warranty

All other components: 12 months from date of installation; if installed 6 months or more after ship date, warranty shall be a maximum of 18 months from ship date.

If a fault develops, notify us, giving a complete description of the alleged malfunction. Include the model number(s), date of delivery and operating conditions of subject product(s). We will subsequently review this information and, at our option, supply you with either servicing data or shipping instruction and returned materials authorization. Upon prepaid receipt of subject product(s) at the instructed destination, we will then either repair or replace such product(s), at our option, and if determined to be a warranted defect, we will perform such necessary product repairs or replace such product(s) at our expense.

This limited warranty does not cover any products, damages or injuries resulting from misuse, neglect, normal expected wear, chemically-caused corrosion, improper installation or operation contrary to factory recommendation. Nor does it cover equipment that has been modified, tampered with or altered without authorization.

No other extended liabilities are stated or implied and this warranty in no event covers incidental or consequential damages, injuries or costs resulting from any such defective product(s).

1365 North Clovis Avenue
Fresno, California 93727 USA
Telephone: (559) 255-1601
FAX: (559) 255-8093
www.lakos.com
info@lakos.com

 Printed on recycled paper LS-624G (Rev. 11/11)